

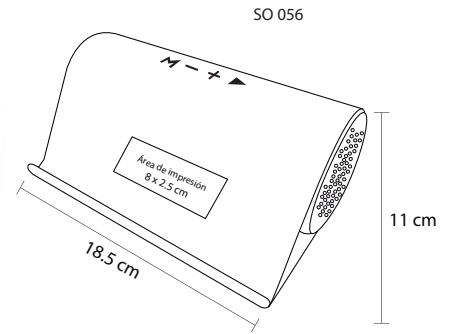

TECNOLOGÍA



## AVICII

SO 056

NUEVO

Bocina portátil de acabado rubber con radio FM, Bluetooth, entrada USB, auxiliar y micro SD. batería recargable con duración de 2-5 horas. Incluye cable de carga.



MT Plástico M 18.5 X 11 cm E 40 Pzas MI 2.5 x 8 cm TI Tampografía



## BEETHOVEN

SO 034

Bocina portátil con porta celular, entrada USB, auxiliar, micro SD y radio FM. Incluye cable de carga. Batería recargable con duración de 4 horas.

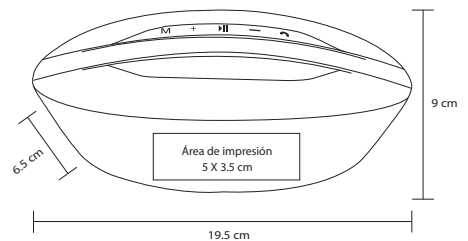

MT Plástico M 19.5 x 9 x 6.5 cm E 50 Pzas MI 5 x 3.5 cm TI Serigrafía / Tampografía / Láser

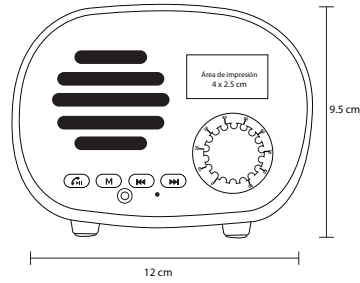

## ROCKOLA

SO 055



Bocina portátil estilo vintage con radio FM, Bluetooth, entrada micro SD y USB batería recargable con duración aprox. de 15 horas. Incluye cable de carga.



- MT** Plástico
- M** 12 X 9.5 cm
- E** 60 Pzas
- MI** 4 x 2.5 cm
- TI** Tampografía

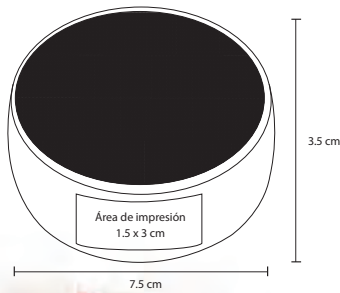

## BAMBATA

SO 033

Bocina portátil, con entrada USB, micro SD, Bluetooth, auxiliar y radio FM, Incluye cable de carga. Batería recargable con duración de 4 horas.



- MT** Metal
- M** 7.5 X 3.5 cm
- E** 100 Pzas
- MI** 1.5 x 3 cm
- TI** Tampografía / Láser





# HANSEL

SO 008

Bocina portátil con Bluetooth, Micro SD, USB, auxiliar y radio. Incluye cable de carga y auxiliar. Batería recargable con duración de 4 hrs.

- MT Plástico
- M 16.5 X 8 cm
- E 50 Pzas
- MI 12 x 15 cm
- TI Tampografía

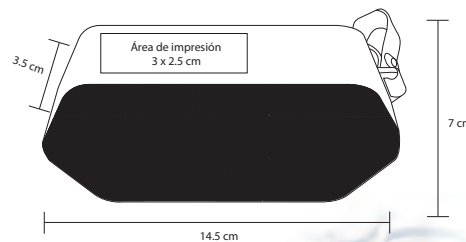
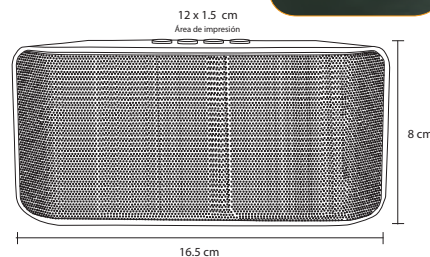

# WAGNER

SO 036

Mini bocina portátil, con correa, entrada USB, micro SD, bluetooth y radio FM. Incluye cable de carga y auxiliar. Batería recargable con duración de 4 horas.

- MT Plástico
- M 14.5 x 7 X 3.5 cm
- E 60 Pzas
- MI 3 x 2.5 cm
- TI Tampografía



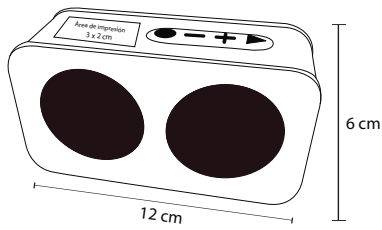

## ACUSTIC

NUEVO

SO 051

Bocina portátil de acabado rubber con Bluetooth, entrada SD, USB, radio FM y botones de color en contraste. Batería recargable con duración de 2-3 horas.



- MT Plástico
- M 12 X 6 cm
- E 100 Pzas
- MI 3 x 2 cm
- TI Tampografía

360°



## ELVIS

SO 032

Bocina portátil, con asa de silicón, entrada USB, micro SD, auxiliar, bluetooth y radio FM, incluye cable de carga. Batería recargable con duración de 4 horas.

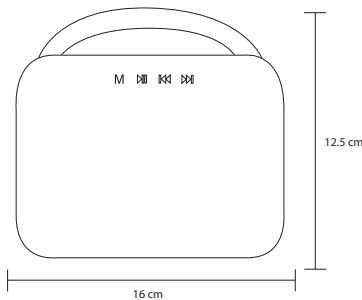
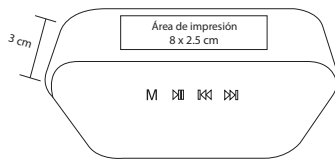

- MT Plástico
- M 16 x 12.5 x 5 cm
- E 50 Pzas
- MI 8 X 2.5 cm
- TI Tampografía

360°



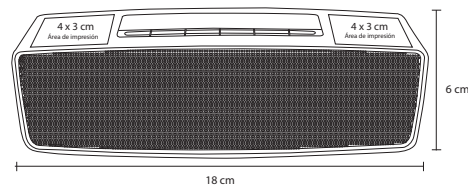

## RADO

SO 006

Bocina portátil con Bluetooth Micro SD, USB y auxiliar. Incluye cables de carga y auxiliar. Batería recargable con duración de 4 hrs.

MT Plástico M 18 X 6 cm E 50 Pzas MI 4 x 3 cm TI Serigrafía / Tampografía



## AMINCI

SO 027

Bocina portátil con bluetooth, micro USB, auxiliar y Micro SD y batería recargable. Incluye cable de carga y auxiliar. Batería recargable con duracion de 4 hrs.

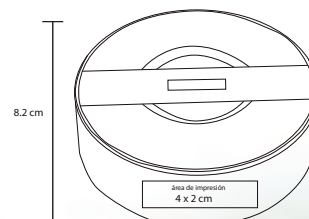

MT Aluminio M 8.2 diámetro E 100 Pzas

MI 4 x 2 cm TI Serigrafía / Tampografía / Láser





# HARRIS

SO 054

NUEVO

Bocina Bluetooth portátil con micro SD, USB y AUX, batería recargable con duración de 1-2 horas. Incluye cable USB para carga.

- MT Plástico
- M 6.5 x 9 cm
- E 100 Pzas
- MI 4 x 3 cm
- TI Serigrafía / Tampografía

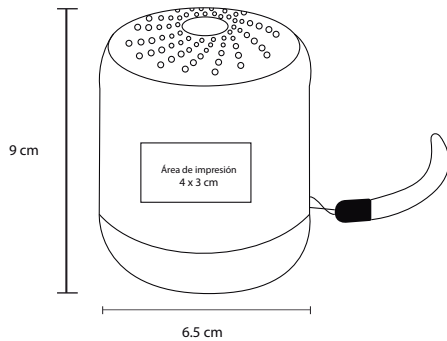

360°



# FEST

SO 019

Bocina portátil de acabado rubber con display, cuenta con Bluetooth, reproductor de audio, lector Micro SD, USB, auxiliar, radio y función manos libres. Incluye cable de carga y auxiliar. Batería recargable con duración de 4 hrs.

- MT Plástico
- M 10.8 X 9.2 cm
- E 60 Pzas
- MI 5 x 5 cm
- TI Serigrafía / Tampografía

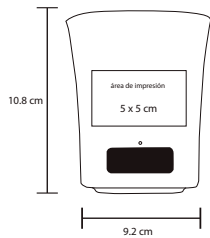



## SHOWER

SO 026

Bocina portátil para baño, con bluetooth y batería recargable. Con duración de 2 hrs  
Incluye cable de carga.

- MT Plástico
- M 5.2 X 8.5 cm
- E 100 Pzas
- MI 3 x 1 cm
- TI Tampografía

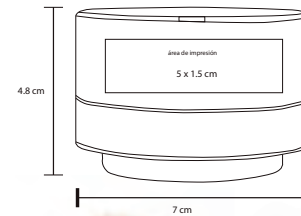
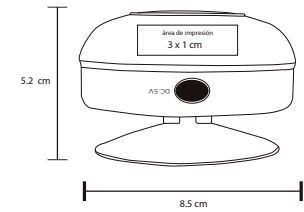

## IKEA

SO 025

Bocina portátil bluetooth y Micro SD.  
Incluye cable de carga. Batería recargable  
con duración de 3 hrs

- MT Aluminio
- M 4.8 X 7 cm
- E 100 Pzas
- MI 5 x 1.5 cm
- TI Serigrafía / Tampografía / Láser





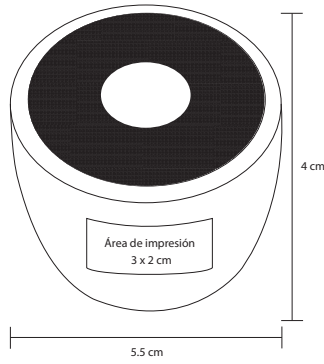

## YANNI

SO 035

Mini bocina portátil, con estuche y bluetooth, Incluye cable de carga. Batería recargable con duración de 4 horas.

MT Metal

M 5.5 x 4 cm

E 100 Pzas

MI 3 x 2 cm

TI Serigrafía / Tampografía / Láser

## RIOMA

SO 007

Bocina portátil con acadado rubber Bluetooth, lector Micro SD, USB, auxiliar y función manos libres. Incluye cable de carga y auxiliar. Batería recargable con duración de 2 horas.

MT Plástico

M 9 x 6 cm

E 50 Pzas

MI 3.5 x 1.5 cm

TI Tampografía

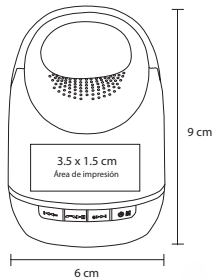



## STRAUSS

SO 043

Audífonos plegables de acabado rubber con conexión de 3,5 mm

MT Plástico M 49 x 16 x 6,5 diámetro E 100 Pzas

MI 4 x 4 cm TI Tampografía

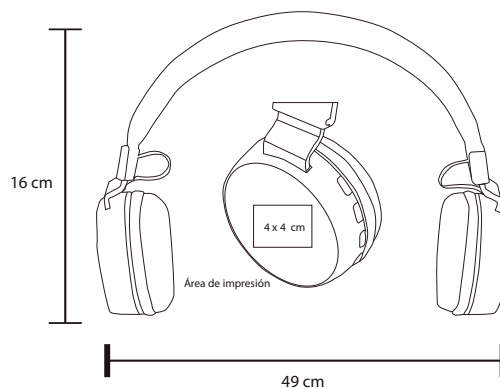

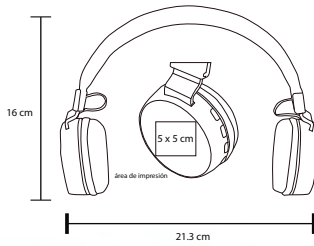

## LOGAN

SO 022

Audífonos plegables Bluetooth con función manos libres. Controles integrados de llamada, volumen y reproducción de audio. Incluye cable cargador, cable auxiliar y estuche.

- MT Aluminio
- M 16 X 21.3 cm
- E 50 Pzas
- MI 5 x 5 cm
- TI Serigrafía / Tampografía / Láser



360°



## ROMY

SO 023

Audífonos bluetooth con batería recargable con duración de 2 hrs Incluye cable cargador USB, gomas de repuesto y estuche.

- MT Plástico
- M 55.5 X 25 cm
- E 200 Pzas
- MI Diametro 15 cm
- TI Serigrafía / Tampografía

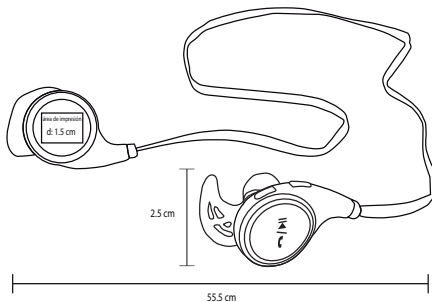



## GUETTA

NUEVO

SO 052

Audífonos bluetooth plegables con conexión de 3.5 mm.

- MT Plástico
- M 53 X 18 cm
- E 100 Pzas
- MI 15 x 15 cm
- TI Tampografía

360°

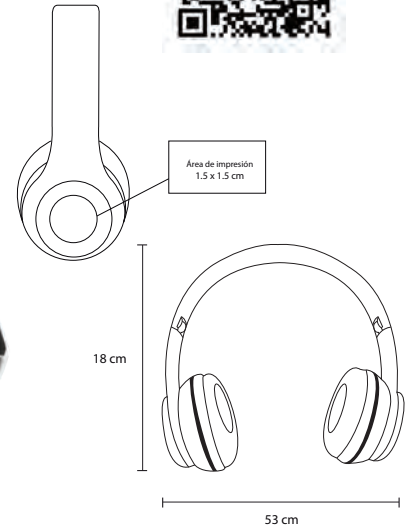

## BRENDEL

NUEVO

SO 053

Audífonos de conexión de 3.5 mm incluye estuche de plástico que se convierte en soporte para celular

- MT Plástico
- M 75 X 7.5 cm
- E 600 Pzas
- MI 3 x 15 cm
- TI Tampografía

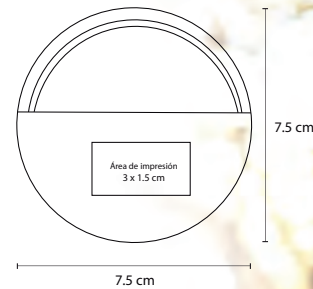

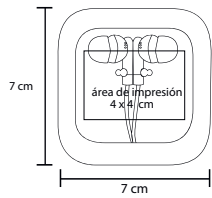

## HELSINKI

3551

Audífonos con estuche y cuatro gomas de repuesto

- MT Plástico
- M 7 x 7 cm
- E 500 Pzas
- MI 4 x 4 cm
- TI Serigrafía / Tampografía

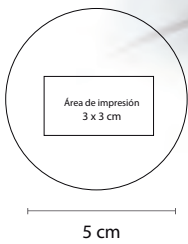

## TURIN

NUEVO

SO 050

Audífonos de conexión de 3.5 mm. Con estuche de plástico.

- MT Plástico
- M 5 X 3.2 cm
- E 600 Pzas
- MI 3 x 3 cm
- TI Tampografía

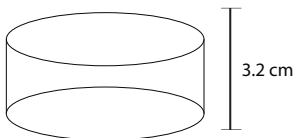



Inalámbrica. Para equipos compatibles con este tipo de carga.

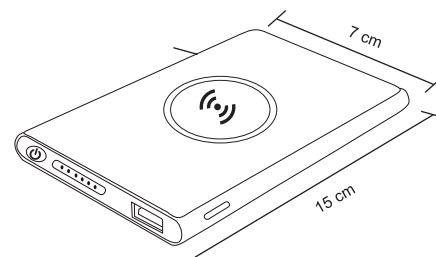

## HOLDY

SO 041

Batería portátil de metal con acabado rubber. Para carga de teléfonos, tablets, cámaras digitales, juegos, mp3, mp4. Incluye cable USB, capacidad de: 8000MAH

MT Plástico / Metal

M 7 x 15 cm

E 50 Pzas

MI 3 x 5 cm

TI Serigrafía / Tampografía



## XANAT

SO 040

Batería portátil de metal, para carga de teléfonos, tablets, cámaras digitales, juegos, mp3, mp4. Incluye cable USB, capacidad de: 10000MAH

MT Plástico / Metal

M 14,5 x 6 cm

E 100 Pzas

MI 6 x 3,5 cm

TI Serigrafía / Tampografía / Láser

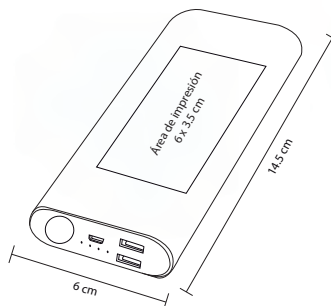

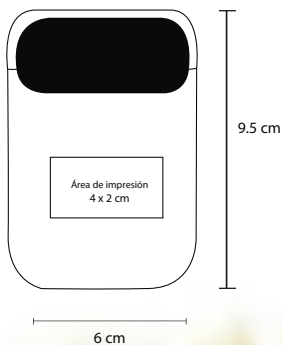

## TEMPUS

NUEVO

SO 058

Batería portátil de acabado rubber y doble salida USB. Capacidad 6000 mAh. Incluye cable USB para carga.

- MT Plástico
- M 9.5 X 6 cm
- E 100 Pzas
- MI 4 x 2 cm
- TI Serigrafía / Tampografía

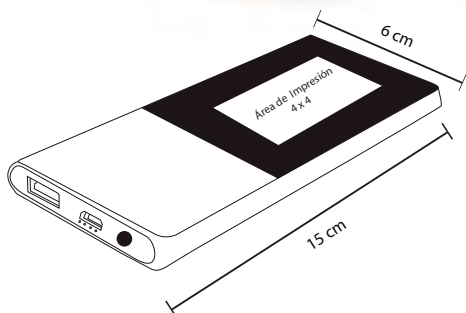

## VIVALDI

SO 039

Batería portátil de metal con acabado rubber. Para carga de teléfonos, tablets, cámaras digitales, juegos, mp3, mp4. Incluye cable USB, capacidad de: 9000mAh

- MT Metal / Plástico
- M 15 X 6 cm
- E 50 Pzas
- MI 4 x 4 cm
- TI Serigrafía / Tampografía / Láser



## LOWER

SO 031

Batería portátil para suministro de cargas de teléfonos, tablets, cámaras digitales, juegos, mp3, mp4. Capacidad 4000 mAh. Incluye cable para carga.

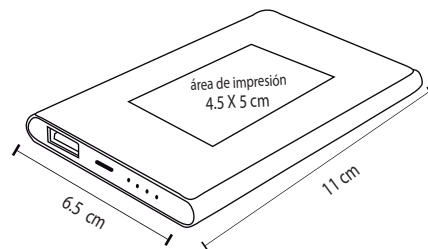

- MT Metal
- M 11 X 6.5 cm
- E 100 Pzas
- MI 45 x 5 cm
- TI Serigrafía / Láser / Tampografía



## CHERRY

SO 037

Batería portátil con acabado rubber, para carga de teléfonos, tablets, cámaras digitales, juegos, mp3, mp4. Incluye cable USB, capacidad de 10,000 mAh

- MT Plástico
- M 14 X 7 cm
- E 100 Pzas
- MI 4 x 8 cm
- TI Serigrafía / Tampografía / Láser

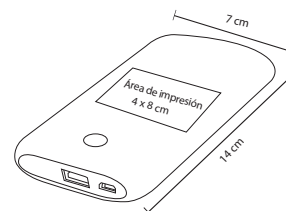





# POISON

NUEVOS  
COLORES

## SO 030

Batería portátil para suministro de cargas de teléfonos, tablets, cámaras digitales, juegos, mp3, mp4. Capacidad 2200 mAh. Incluye cable para carga.

- MT Metal
- M 9.5 X 2.2 cm
- E 100 Pzas
- MI 4 x 12 cm
- TI Serigrafía / Láser / Tampografía

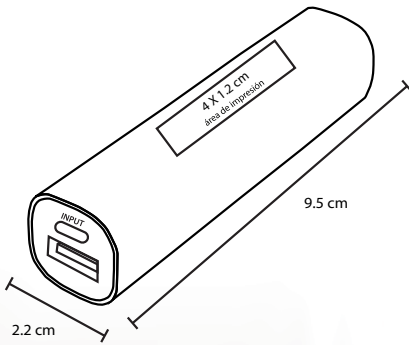

# AMET

## SO 038

Batería portátil de plástico, para carga de teléfonos, tablets, cámaras digitales, juegos, mp3, mp4. Incluye cable USB, capacidad de 4000mAh

- MT Plástico
- M 10 x 5.2 cm
- E 100 Pzas
- MI 6 x 2.5 cm
- TI Serigrafía / Tampografía

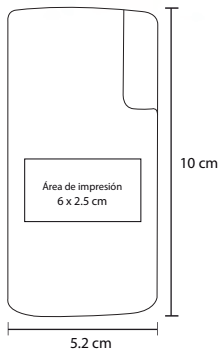



## BAKAN

SO 042

Batería portátil de plástico, para carga de teléfonos, tablets, cámaras digitales, juegos, mp3, mp4. Incluye cable USB, capacidad de: 2200 MAH

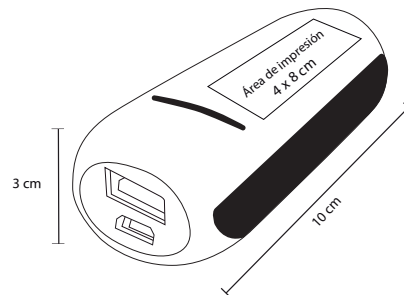

MT Plástico M 10 X 3 X 16 cm E 100 Pzas MI 5 X 15 cm TI Serigrafía / Tampografía



## IRISH

SO 045

Set que incluye power bank, cable con 3 salidas, adaptador de carga para auto, de pared, audífonos y adaptador 3.5 mm con entrada doble de cable

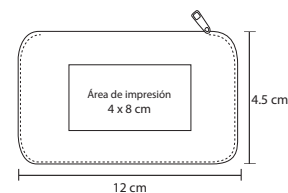

MT Plástico M 12 X 4.5 cm E 200 Pzas MI 4 x 8 cm TI Serigrafía / Tampografía

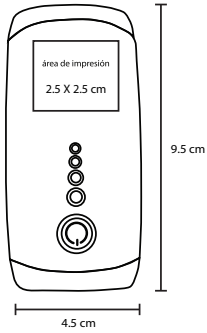

## DREMER

SO 029

Batería portátil para suministro de carga de teléfonos, tablets, cámaras digitales, juegos, mp3, mp4. Capacidad 3000 mAh. Incluye cable para carga.

- MT Plástico
- M 9.5 X 4.5 cm
- E 100 Pzas
- MI 2.5 x 2.5 cm
- TI Serigrafía / Tampografía



## AMPERE

SO 060

Carpeta de poliéster con block de 98 hojas rayadas, compartimiento para tarjetas, porta bolígrafo, cierre magnético, batería de 8000 mAh y cables.



- MT Poliéster
- M 17.5 x 23.5 cm
- E 50 Pzas
- MI 6 x 5 cm
- TI Serigrafía

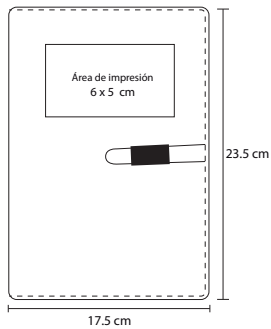



## KIMSTAR

SO 049

Memoria USB metálica en forma de llave. Cap. 16 GB

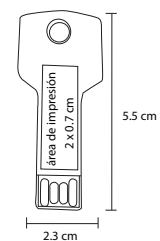

## DMAX

SO 046

Boligrafo con USB Cap. 16 GB y touch screen

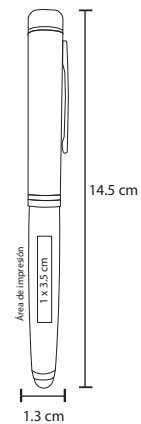

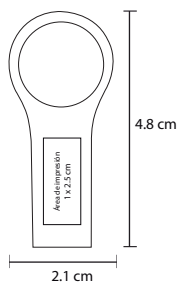

## DUSTER

### SO 047

Mini memoria USB de cuerpo metálico.  
Cap. 32 GB

- MT** Metal
- M** 48 x 21 cm
- E** 500 Pzas
- MI** 1 x 2,5 cm
- TI** Serigrafía / Tampografía / Láser

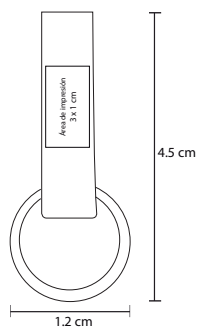

## ELICE

### SO 048

Mini memoria USB de cuerpo metálico.  
Cap. 32 GB

- MT** Metal
- M** 45 x 12 cm
- E** 500 Pzas
- MI** 3 x 1 cm
- TI** Serigrafía / Tampografía / Láser





## FALCON

SO 064

Memoria USB de acrílico transparente con luz azul. Capacidad de 16 GB.

NUEVO

- MT Acrílico
- M 5.7 X 2 cm
- E 500 Pzas
- MI 1 x 15 cm
- TI Tampografía / Láser

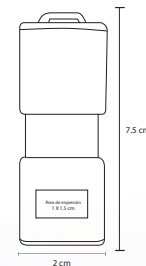

## STORAGE

SO 012

Mini memoria USB de cuerpo metálico. Cap. 8 GB

- MT Metal
- M 4 X 12 cm
- E 500 Pzas
- MI 2 x 0.7 cm
- TI Serigrafía / Láser / Tampografía

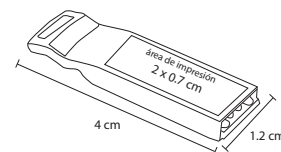

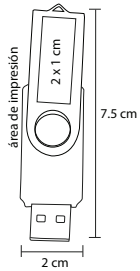

## KEYLOR

SO 010

Memoria USB con protector de metal giratorio y cuerpo de goma. Cap. 8 GB

- MT Plástico / Metal
- M 2 X 7.5 cm
- E 500 Pzas
- MI 2 x 1 cm
- TI Serigrafía / Láser / Tampografía

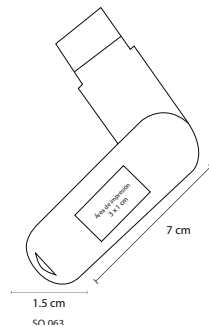

## NAVIUM

SO 065

Memoria USB acabado metalico con protector giratorio. Capacidad de 8 GB.

- MT Metal
- M 7 X 15 cm
- E 500 Pzas
- MI 3 x 1 cm
- TI Tampografía / Láser

NUEVO





# BUKA

SO 017

Cable cargador USB con salida de 8 pines, salida tipo C y micro USB, incluye sujetador de cables retráctil. (Longitud de cable 90 cm)

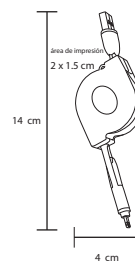

- MT Plástico
- M 14 X 4 cm
- E 500 Pzas
- MI 2 x 1.5 cm
- TI Serigrafía / Tampografía / Gota de Resina



# KABEL

SO 059

Cable multi USB 4 en 1, compatible con android y Iphone, tipo C. Diseño suspenible, portátil y ligero.

**NUEVO**

- MT Metal / Plástico
- M 15 X 14 cm
- E 500 Pzas
- MI 0.8 x 2 cm
- TI Tampografía / Grabado

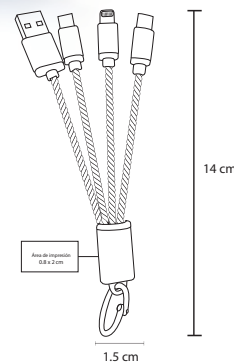



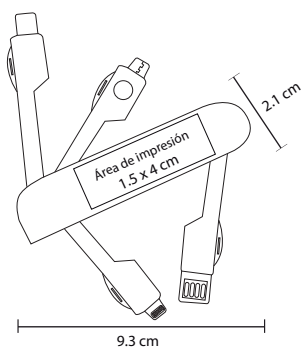

## KIRIA

SO 044

Set de cables para cargar dispositivos, con entrada para Iphone, micro y tipo C

- MT Plástico
- M 9.3 x 2.1 cm
- E 1000 Pzas
- MI 15 x 4 cm
- TI Serigrafía / Tampografía

## TRAVEL

SO 016

Adaptador universal de corriente con dos entradas USB. Puede recibir desde 110V y hasta 250V para adaptarse a los diferentes suministros de energía del mundo.

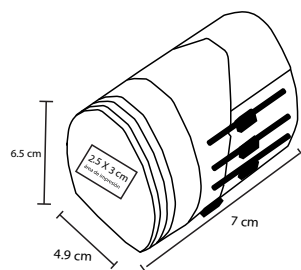

- MT Plástico
- M 7 X 6.5 cm
- E 100 Pzas
- MI 2.5 X 3 cm
- TI Serigrafía / Tampografía





## YEAL

SO 021

Adaptador de corriente para auto con dos entradas USB 10A y 2.1A.

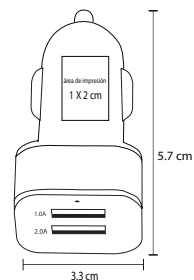

- MT Plástico
- M 5,7 x 3,3 cm
- E 1000 Pzas
- MI 1 x 2 cm
- TI Serigrafía / Tampografía



## ARUBA

SO 020

Adaptador de corriente para auto con entrada USB.

- MT Plástico
- M 5,5 X 2,3 cm
- E 1000 Pzas
- MI 2 x 1 cm
- TI Serigrafía / Tampografía

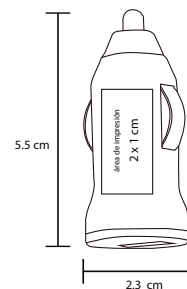

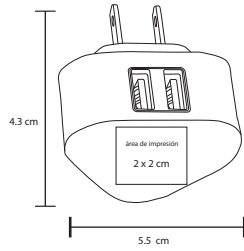

# VANEK

SO 013

Adaptador de corriente con doble entrada para USB, compatible con dispositivos móviles.

- MT Plástico
- M 4.3 X 5.5 cm
- E 500 Pzas
- MI 2 x 2 cm
- TI Serigrafía / Tampografía



# SUPPORTO

SO 061

Soporte de escritorio para teléfono celular.

- MT Plástico
- M 6 X 7.5 cm
- E 500 Pzas
- MI 4 x 3 cm
- TI Tampografía

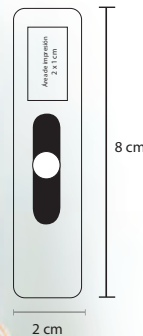
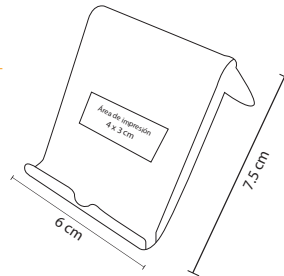

# CAMEL

SO 057

Encendedor electrónico con resistencia recargable por USB.

- MT Plástico
- M 8 X 2 cm
- E 1000 Pzas
- MI 2 x 1 cm
- TI Tampografía



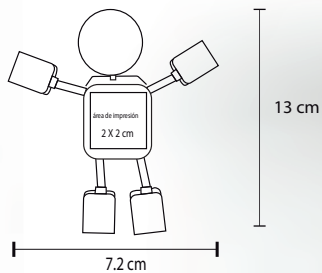

## PRIMUL

SO 024

Hub USB con cuatro puertos.

MT Plástico M 13 x 7.2 cm E 500 Pzas

MI 2 x 2 cm TI Serigrafía / Tampografía



## VENTO

SO 063

Tarjetero universal de silicón para celular.

MT Silicón M 5.5 x 8.5 cm E 3000 Pzas

MI 4 x 2 cm TI Serigrafía

NUEVO

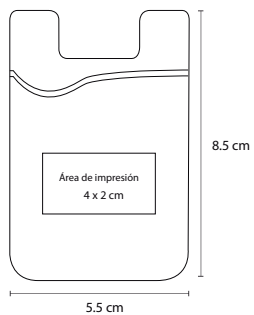



## LOLYPOP

NUEVO

SO 062

Sujetador plegable con base independiente para coche.

MT Plástico

M 4 X 4 cm

E 1000 Pzas

MI 2 x 2 cm

TI Tampografía / Gota de resina

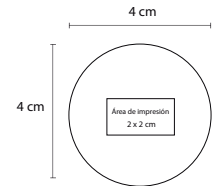

## KOSS

SO 028

Selfie stick con cable de 3.5mm y botón para tomar fotos, cuenta con tubo extensible de 48.8 cm para mejor manejo. No requiere baterías.

MT Metal / Plástico

M 16.6 X 3.5 cm

E 50 Pzas

MI 5 x 2.5 cm

TI Serigrafía / Tampografía

